

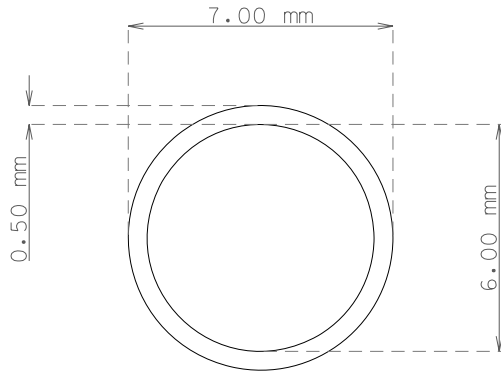

PIEZA
PART

TUBO ACERO INOXIDABLE AISI-316 7,0 X 0,50 mm
STAINLESS STEEL TUBE AISI-316 7,0 X 0,50 mm



escala 5:1

escala 1:1

<p>ARTICULO ITEM</p>	<p>TUBO INOX AISI-316 7,0 X 0,50 mm INOX.TUBE AISI-316 7,0 X 0,50 mm</p>	
<p>CARACTERISTICAS TECNICAS TECHNICAL FEATURES</p>	<p>TUBO SOLDADO Y REESTIRADO CALIBRADO EXTERIOR E INTERIOR \varnothing EXTERIOR 7,0 \pm 0,05 / \varnothing INTERIOR 6,00 \pm 0,05 mm ACABADO : BRILLANTE TRATAMIENTO : DURO PESO Kg/Mts: 0,0817 PRESION TRABAJO : 107 Kg / Cm² WELDED AND REDRAWN TUBE CALIBRATED EXTERNAL AND INTERNAL \varnothing EXTERNAL 7,0 \pm 0,05 / \varnothing INTERNAL 6,00 \pm 0,05 FINISHING : BRIGHT TREATMENT : HARD WEIGHT Kg/m: 0,0817 WORK PRESSURE : 107 Kg / Cm²</p>	
<p>OBSERVACIONES REMARKS</p>	<p>SUMINISTROS EN BARRAS DE 2,00 MTS LENGH 2,00 MTS</p>	
<p>PLANO N° DRAWING N°</p>	<p>705060-21</p>	<p>A4</p>
<p>REF. TUBO</p>	<p>01-0700-050-200021</p>	