

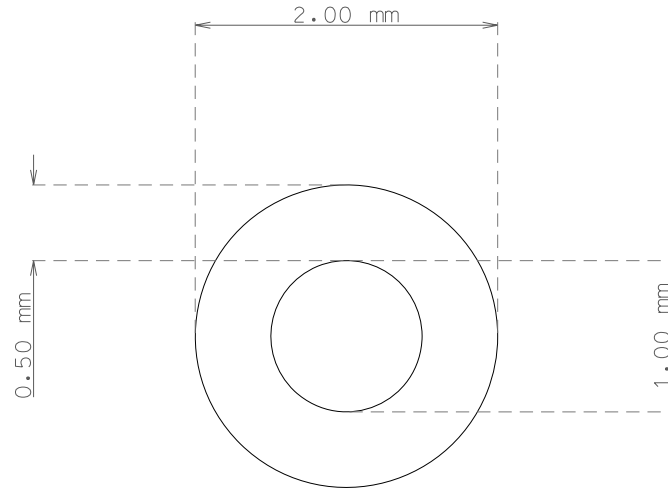

PIEZA
PART

TUBO ACERO INOXIDABLE AISI-304 2,0 X 0,50 mm
STAINLESS STEEL TUBE AISI-304 2,0 X 0,50 mm



escala 20 : 1

<p>ARTICULO ITEM</p>	<p>TUBO INOX AISI-304 2,0 X 0,50 mm INOX.TUBE AISI-304 2,0 X 0,50 mm</p>	
<p>CARACTERISTICAS TECNICAS TECHNICAL FEATURES</p>	<p>TUBO SOLDADO Y REESTIRADO CALIBRADO EXTERIOR E INTERIOR \varnothing EXTERIOR $2,0 \pm 0,02$ / \varnothing INTERIOR $1,0 \pm 0,02$ mm ACABADO : BRILLANTE TRATAMIENTO : DURO PESO Kg/Mts: 0,0189 PRESION TRABAJO : 375 Kg / Cm² WELDED AND REDRAWN TUBE CALIBRATED EXTERNAL AND INTERNAL \varnothing EXTERNAL $2,0 \pm 0,02$ / \varnothing INTERNAL $1,0 \pm 0,02$ FINISHING : BRIGHT TREATMENT : HARD WEIGHT Kg/m: 0,0189 WORK PRESSURE : 375 Kg / Cm²</p>	
<p>OBSERVACIONES REMARKS</p>	<p>SUMINISTROS EN BARRAS DE 2,00 MTS LENGH 2,00 MTS</p>	
<p>PLANO N° DRAWING N°</p>	<p>205010-11</p>	<p>A4</p>
<p>REF. TUBO</p>	<p>01-0200-050-200011</p>	